



DaxLite

2018 LIGHTING CATALOGUE
Version 8



WELCOME...



...to the latest edition of our catalogue. Those of you who are already our valued customers and are familiar with DaxLite, will know that we strive to go that extra mile. If you haven't tried us before, let me give you a few key reasons why our customers buy from us.

As a medium sized family run company with over 30 years experience in the lighting industry. Operating from our manufacturing plants in Asia, we are able to combine technology, expertise and quality at a very competitive price. Our integrity and putting our customers at the centre of everything we do are what keeps our customers coming back.

We at DaxLite enjoy what we do and our customers reap the benefits. Contact our dedicated sales team today with your lighting queries.

Thank you for taking the time to look through our catalogue.

BARRY SAMSON
Director



Multi-Platform Website



DAX GUIDE



BULKHEADS **04**



DOWNLIGHTS **06**



SHAVER LIGHTS **18**



COMMERCIAL **19**



OUTDOOR **22**

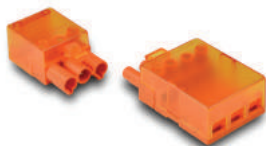

ACCESSORIES **26**



TECHNICAL **29**



DAXBULKHEAD'S

18W LED DECORATIVE LUNAR BULKHEAD

- IP65 decorative lunar high output bulkhead fitting
- Durable impact resistant polycarbonate construction
- Suitable for commercial and domestic environments
- 30,000 Hours average life



↑ DXSMDLUNAR



↑ DXMICROSDLUNAR

- IP IP65 Rated
- 3 Year Standard Product Warranty
- Microwave Sensor Options Available

Class
IP65 240V

LED
White 4000K CRI: Ra (80)

Wattage
18W

Lumens
SMDLUNAR/
MICROSDLUNAR:
1400 Lumens
90 Lm/W

Finish
White Base

Construction
Body - Polycarbonate
Diffuser - Polycarbonate

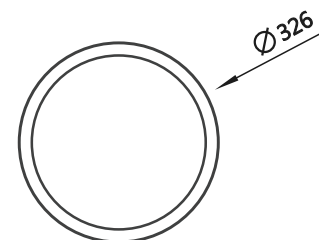

Code	Description
DXSMDLUNAR	18W LED Lunar Bulkhead, Opal Diffuser, White Base
DXMICROSDLUNAR	18W LED Lunar Bulkhead c/w Micro Sensor, Opal Diff, White Base

BULKHEADS

- IP** IP65 Rated
- 2 Year** Standard Product Warranty

DAXBULKHEAD's

IP65 12W/20W ROUND BULKHEAD

- High output wall or ceiling light
- 2D replacement. LED performance exceeds CFL equivalents
- 30,000 hours average lifetime
- Impact resistant polycarbonate design

Class
IP65 240V Ⓢ Ⓡ

LED
White 4000K CRI: Ra (75)

Wattage
12/20W Models

Lumens
12W: 850 Lumens
60 Lm/W
20W: 1400 Lumens
60 Lm/W

Finish
White or Black Base

Construction
Body - Polycarbonate
Diffuser - Opal Polycarbonate
IK10 Rating

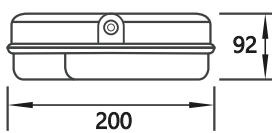

DXSMDRDMAX12

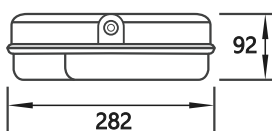

DXSMDRDMAX20



↑ DXSMDRDMAX12BO



↑ DXSMDRDMAX20WO



↑ DXSMDRDMAX12WO



↑ DXSMDRDMAX20BO

Code	Description
DXSMDRDMAX12WO	12W LED Bulkhead, Opal Diffuser, White Base
DXSMDRDMAX12BO	12W LED Bulkhead, Opal Diffuser, Black Base
DXSMDRDMAX20WO	20W LED Bulkhead, Opal Diffuser, White Base
DXSMDRDMAX20BO	20W LED Bulkhead, Opal Diffuser, Black Base

5
BULKHEADS



DAXBUD

INTEGRATED FIRE RATED DOWNLIGHT

- Quality downlight to suit every budget
- Cost effective without compromise on quality
- 50,000 hours average lifetime
- Screwless loop in/out terminal connector
- The DaxBUD comes complete with a white bezel
- All bezels are interchangeable with the DaxBUD, DaxELITE & DaxPRO



← DXBD410 + DXFBZSS

Innovative flexi driver can be flipped 180° and repositioned around objects. The DaxBUD will accommodate min void spaces of 65mm

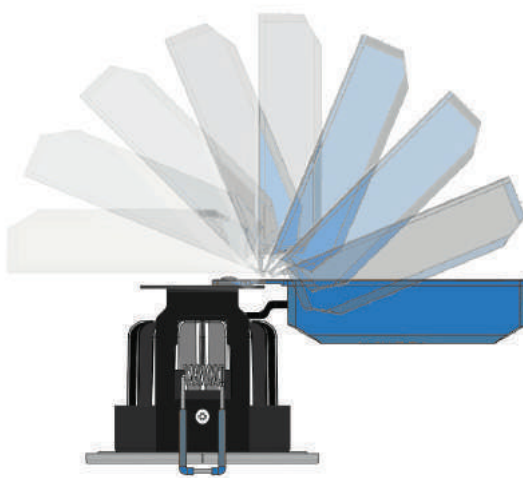

← Interchangeable die-cast aluminium bezels
 DXFBZBK Black
 DXFBZCH Polished Chrome
 DXFBZPB Polished Brass
 DXFBZSS Satin Silver
 DXFBZSW White

IP IP65 Rated

Fire Rated
 30/60/90 Minute Rated

Acoustic Rated
 Part C Building Reg Compliant

5 Year
 Standard Product Warranty

Class
 IP65 240V ⊕

LED
 4000K (W) CRI: Ra (80)
 3000K (WW) CRI: Ra (80)

Wattage
 10W Dimmable





Lumens
 10W 4000K: 700 Lm
 10W 3000K: 650 Lm

Finish
 Black, Polished Brass,
 Polished Chrome,
 Satin Silver & White

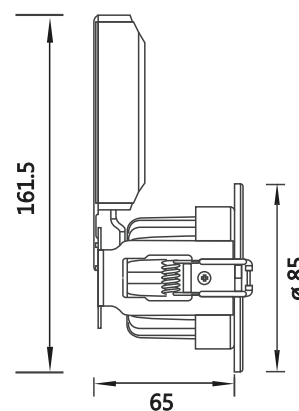
Construction
 Body - Aluminium

Cutout Sizes
 ø 75mm



-  IP65 Rated
-  Fire Rated
30/60/90 Minute Rated
-  Acoustic Rated
Part C Building Reg Compliant
-  5 Year
Standard Product Warranty

DAXBUD

INTEGRATED FIRE RATED DOWNLIGHT

- Screwless connector for fast installation
- Heavy duty IC bracket allows overlay of insulation

Class
IP65 240V ⚡

LED
4000K (W) CRI: Ra (80)
3000K (WW) CRI: Ra (80)

Wattage
10W Dimmable

Lumens
10W 4000K: 700 Lm
10W 3000K: 650 Lm

Finish
Black, Polished Brass,
Polished Chrome,
Satin Silver & White

Construction
Body - Aluminium

Cutout Sizes
ø 75mm

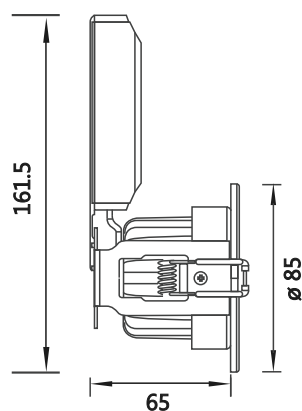

Screwless terminal connector supplied with the DaxBUD allows for fast, efficient installation



- The DaxBUD is our budget fire rated downlight
- This COB LED downlight is available in two different colour temperature 10W dimmable models.
- Fully tested to 30, 60 & 90 minutes.
- Part B, E, C, L compliant.
- IP65 Rated, suitable for bathrooms/ wet-rooms.
- Soft On/Off Dimming

Code	Description
DXBD310	DaxBUD 10W COB LED Dimmable Integrated FRD. 3000K. IP65
DXBD410	DaxBUD 10W COB LED Dimmable Integrated FRD. 4000K. IP65
DXFBEZBK	Black Die-cast Interchangeable Bezel
DXFBEZCH	Polished Chrome Die-cast Interchangeable Bezel
DXFBEZPB	Polished Brass Die-cast Interchangeable Bezel
DXFBEZSS	Satin Silver Die-cast Interchangeable Bezel
DXFBEZWH	White Die-cast Interchangeable Bezel

DOWNLIGHTS



DAXPRO

INTEGRATED FIRE RATED DOWNLIGHT

- Professional COB LED downlight
- High quality components enhances longevity
- 80,000 hours average lifetime
- Fast fix 20 Amp 4 terminal connector
- All bezels are interchangeable with the DaxBUD, DaxELITE & DaxPRO





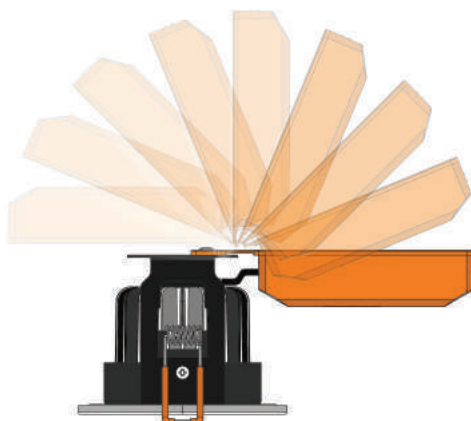

DXD410 + DXFBEZSS 

Innovative flexi driver can be flipped 180° and repositioned around objects. The DaxPRO will accommodate min void spaces of 65mm 



 Interchangeable die-cast aluminium bezels
 DXFBEZBK Black
 DXFBEZCH Polished Chrome
 DXFBEZPB Polished Brass
 DXFBEZSS Satin Silver
 DXFBEZW White

Code	Description
DXD310	10W COB LED Dimmable Integrated FRD. 3000K. IP65
DXD410	10W COB LED Dimmable Integrated FRD. 4000K. IP65
DX35	5W COB LED Non Dimmable Integrated FRD. 3000K. IP65
DX45	5W COB LED Non Dimmable Integrated FRD. 4000K. IP65
DXFBEZBK	Black Die-cast Interchangeable Bezel
DXFBEZCH	Polished Chrome Die-cast Interchangeable Bezel
DXFBEZPB	Polished Brass Die-cast Interchangeable Bezel
DXFBEZSS	Satin Silver Die-cast Interchangeable Bezel
DXFBEZW	White Die-cast Interchangeable Bezel

-  IP65 Rated
-  Fire Rated
30/60/90 Minute Rated
-  Acoustic Rated
Part C Building Reg Compliant
-  10 Year
Extendable Product Warranty

Class
IP65 240V 

LED
4000K (W) CRI: Ra (80)
3000K (WW) CRI: Ra (80)

Wattage
5W Non Dimmable
10W Dimmable

Lumens
10W 4000K: 700 Lm
10W 3000K: 650 Lm
5W 4000K: 450 Lm
5W 3000K: 400Lm

Finish
Black, Polished Brass,
Polished Chrome,
Satin Silver & White

Construction
Body - Aluminium

Cutout Sizes
ø 75mm

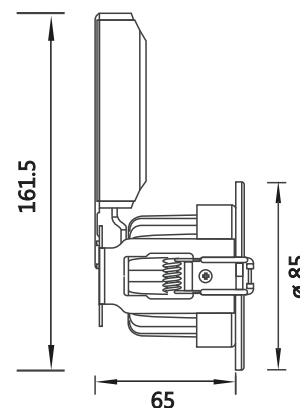

IP IP20 Rated

DXCPLATE

DOWNLIGHT CONVERTER PLATE

- Hole converter plates for the DaxBUD, DaxELITE and DaxPRO downlight range
- Retrofit for existing holes from 75mm to 150mm
- Heavy duty, rubber tipped spring clips supplied



DXCPLATEW



Class
IP20

Finish
Polished Chrome,
Satin Silver & White

Construction
Mild Steel

Cutout Sizes
ø 75- 150mm

DaxPRO fitting displayed for illustrative purposes only. DaxPRO fitting not supplied with converter plates.

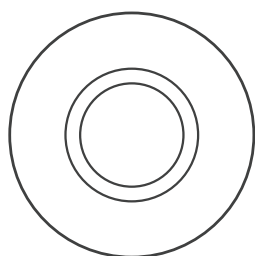
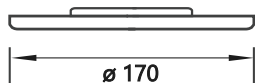

Code	Description
DXCPLATECH	Polished Chrome Converter Plate
DXCPLATESS	Satin Silver Converter Plate
DXCPLATEW	White Converter Plate

N.B. Downlight fire & IP ratings will not apply if used in conjunction with DXCPLATE range



DAXELITE

3 x CCT INTEGRATED FIRE RATED DOWNLIGHT

- 3 Colour switchable COB LED 3000K, 4000K & 6000K
- Supplied with 3 die-cast aluminium bezels Chrome, Satin Silver & White
- 50,000 hours average lifetime
- Fast fix 20Amp 4 terminal connector
- 7 Year product warranty
- All bezels are interchangeable with the DaxBUD, DaxELITE & DaxPRO



← DXEDF10 + DXFBEZW

Innovative flexi driver can be flipped 180° and repositioned around objects. The DaxELITE will accommodate min void spaces of 65mm

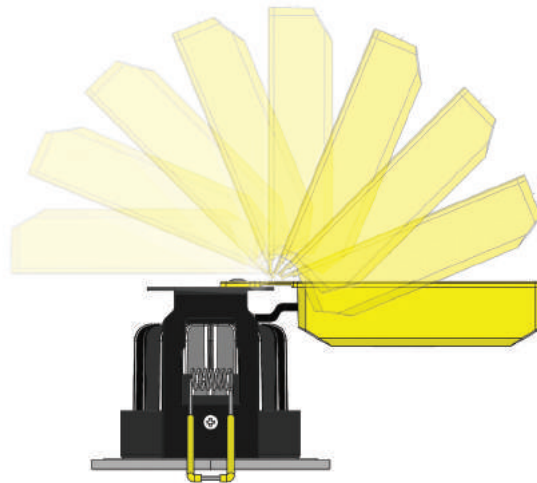

- ← Interchangeable die-cast aluminium bezels
 - DXFBEZBK Black
 - DXFBEZCH Polished Chrome
 - DXFBEZPB Polished Brass
 - DXFBEZSS Satin Silver
 - DXFBEZSW White

IP IP65 Rated

Fire Rated
30/60/90 Minute Rated

Acoustic Rated
Part C Building Reg Compliant

7 Year
Domestic Warranty
5 Year
Commercial Warranty

Class
IP65 240V ⊕

LED
6000K (DL) CRI: Ra (80)
4000K (W) CRI: Ra (80)
3000K (WW) CRI: Ra (80)

Wattage
10W Dimmable

Lumens
10W 6000K: 650 Lm
10W 4000K: 600 Lm
10W 3000K: 550 Lm

Finish
Black, Polished Brass,
Polished Chrome,
Satin Silver & White





Construction
Body - Aluminium

Cutout Sizes
ø 75mm

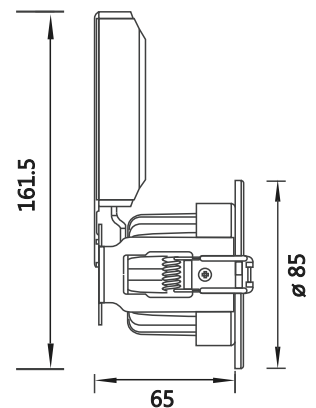

DXEDF10



-  IP65 Rated
-  Fire Rated
30/60/90 Minute Rated
-  Acoustic Rated
Part C Building Reg Compliant
-  7 Year
Domestic Warranty
-  5 Year
Commercial Warranty

Class
IP65 240V ⊕

LED
6000K (DL) CRI: Ra (80)
4000K (W) CRI: Ra (80)
3000K (WW) CRI: Ra (80)

Wattage
10W Dimmable

Lumens
10W 6000K: 650 Lm
10W 4000K: 600 Lm
10W 3000K: 550 Lm

Finish
Black, Polished Brass,
Polished Chrome,
Satin Silver & White

Construction
Body - Aluminium

Cutout Sizes
ø 75mm

CE

DXEDF10

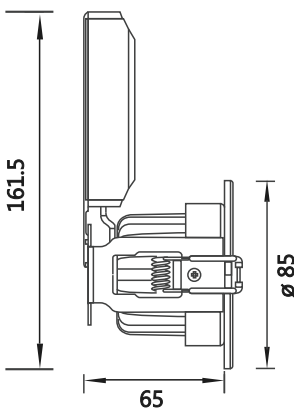

DAXELITE

Features

- Commercial colour switching mechanism
- Heavy duty IC bracket allows overlay of insulation
- Acoustic, moisture & fire rated
- Fitted with heavy duty spring clips ensures a tight seal with the ceiling

3 position switch combines three colour temperature in 1 downlight →



DOWNLIGHTS



- The DaxELITE is the latest edition to our Fire Rated Downlighter collection.
- This 10W dimmable COB LED downlight offers a combined 9 in 1 lighting solution. Sold complete with white, chrome & brushed chrome bezels as well as switchable between 3 colour temperatures.
- Fully tested to 30, 60 & 90 minutes.
- Part B, E, C, L compliant.
- IP65 Rated, suitable for bathrooms/ wet-rooms.
- Soft On/Off Dimming

Code	Description
DXEDF10	DaxELITE 9 in 1 10W Switchable 3 x CCT COB LED Dimmable IP65 FRD Includes White, Polished & Satin Chrome Die-Cast Interchangeable Bezels
DXFBEZBK	Black Die-cast Interchangeable Bezel
DXFBEZCH	Polished Chrome Die-cast Interchangeable Bezel
DXFBEZPB	Polished Brass Die-cast Interchangeable Bezel
DXFBEZSS	Satin Silver Die-cast Interchangeable Bezel
DXFBEZW	White Die-cast Interchangeable Bezel



DAXTILT

TILT D.O.B INTEGRATED FIRE RATED DOWNLIGHT

- Fire rated tilt D.O.B dimmable LED downlight
- Die-cast aluminium bezel
- Built-in driver and fast fix connector
- 5 year product warranty

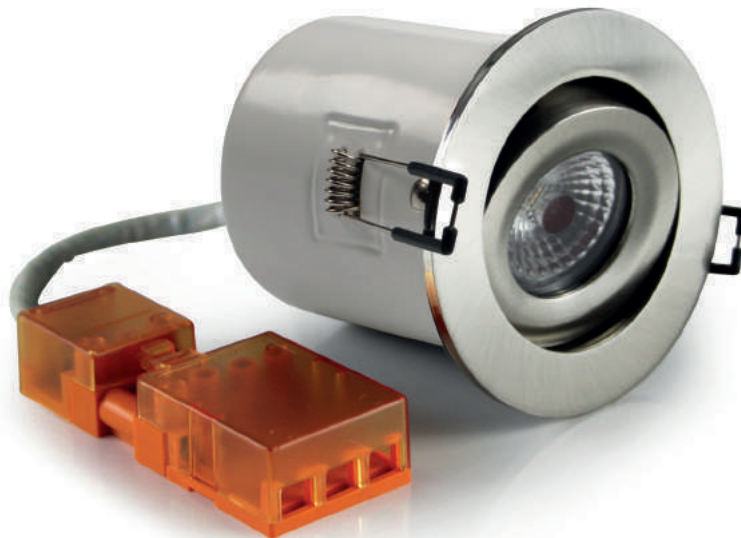

DXDT410 →



Code	Description
DXDT310	10W D.O.B Dimmable Integrated FRD. 3000K.
DXDT410	10W D.O.B Dimmable Intergrated FRD. 4000K.

IP IP40 Rated

Fire Rated
30/60/90 Minute Rated

5 Year
Standard Product Warranty

Class
IP40 240V ⚡

Finish
Polished Chrome,
Satin Silver & White

LED
4000K (W) CRI: Ra (80)
3000K (WW) CRI: Ra (80)

Wattage
10W Dimmable

Lumens
4000K: 700 Lm
3000K: 650 Lm

Beam Angle
60°

Tilt Angle
25°

Construction
Body - Steel

Cutout Sizes
ø 86mm

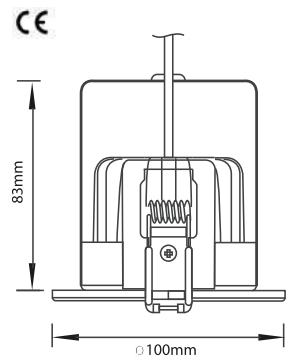

DXTBEZ

DAXTILT DIE CAST BEZELS

- Die-cast aluminium tilt twist & lock bezels
- White, Chrome and Satin Silver finishes available
- Compatible with all DaxTilt models



← DXTBEZW

DXTBEZSS →



← DXTBEZCH

Finish
Polished Chrome,
Satin Silver & White

Construction
Die Cast Aluminium
Tempered Glass Lens

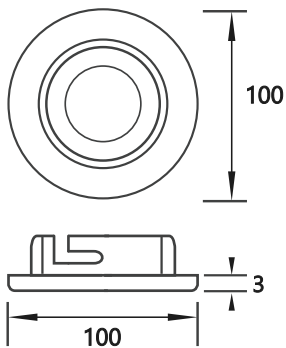





Code	Description
DXTBEZCH	Tilt Die-Cast Polished Chrome Interchangeable Bezel for DaxTilt
DXTBEZSS	Tilt Die-Cast Satin Silver Interchangeable Bezel for DaxTilt
DXTBEZW	Tilt Die-Cast White Interchangeable Bezel for DaxTilt



DAXGU10's

FIXED GU10 DIE CAST FIRE RATED DOWNLIGHT

- Fire rated fixed downlight
- Die-cast aluminium twist & lock bezel
- 15 Amp large 3 terminal connector allows for loop-in/loop-out wiring
- Lifetime product warranty

-  IP20 Rated
-  Fire Rated
30/60/90 Minute Rated
-  Acoustic Rated
Part C Building Reg Compliant
-  Lifetime
Product Warranty

DOWNLIGHTS



← DXGUF17W

DXGUF17CH →



← DXGUF17SS

Class
IP20 240V ⊕





Finish
Black, Polished Brass,
Polished Chrome,
Satin Silver & White

Lamp
GU10 Cap
(Fitting Exc Lamp)

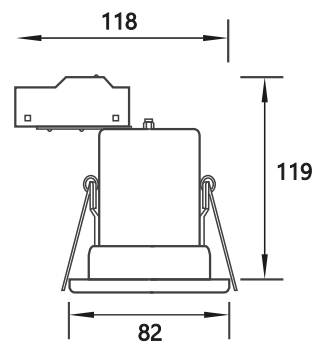
Construction
Body - Pressed Steel
Bezel - Die Cast Aluminium

Cutout Sizes
ø 70mm



-  IP20 Rated
-  Fire Rated
30/60/90 Minute Rated
-  Acoustic Rated
Part C Building Reg Compliant
-  Lifetime
Product Warranty

DAXGU10's

FIXED GU10 DIE CAST FIRE RATED DOWNLIGHT

- Fire rated fixed downlight
- Die-cast aluminium twist & lock bezel
- 15 Amp large 3 terminal connector allows for loop-in/loop-out wiring
- Lifetime product warranty



← DXGUF17PB



DXGUF17BK →

Class
IP20 240V ⊕

Finish
Black, Polished Brass,
Polished Chrome,
Satin Silver & White

Lamp
GU10 Cap
(Fitting Exc Lamp)

Construction
Body - Pressed Steel
Bezel - Die Cast Aluminium

Cutout Sizes
ø 70mm

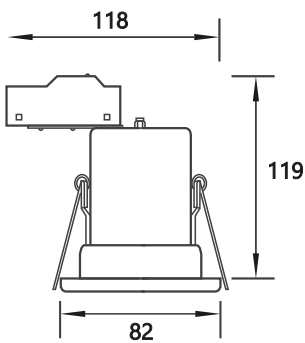

Code	Description
DXGUF17CH	Fixed Chrome GU10 Fire Rated Die Cast Downlight Exc Lamp
DXGUF17BK	Fixed Black GU10 Fire Rated Die Cast Downlight Exc Lamp
DXGUF17SS	Fixed Satin Silver GU10 Fire Rated Die Cast Downlight Exc Lamp
DXGUF17W	Fixed White GU10 Fire Rated Die Cast Downlight Exc Lamp
DXGUF17PB	Fixed Polished Brass GU10 Fire Rated Die Cast Downlight Exc Lamp



DAXGU10's

TILT GU10 DIE CAST FIRE RATED DOWNLIGHT

- Fire rated tilt downlight
- Die-cast aluminium twist & lock bezel
- 15 Amp large 3 terminal connector allows for loop-in/loop-out wiring
- Lifetime product warranty

- IP20 Rated
- Fire Rated
30/60/90 Minute Rated
- Acoustic Rated
Part C Building Reg Compliant
- Lifetime
Product Warranty



← DXGUF7W



DXGUF7CH →



← DXGUF7SS

DOWNLIGHTS

Class
IP20 240V ⊕

Finish
Polished Brass,
Polished Chrome,
Satin Silver & White

Lamp
GU10 Cap
(Fitting Exc Lamp)



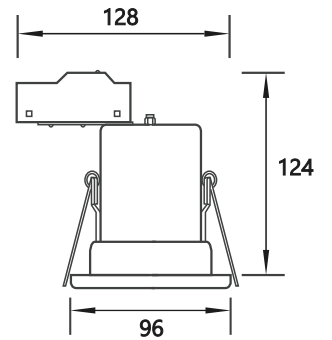

Construction
Body - Pressed Steel
Bezel - Die Cast Aluminium

Cutout Sizes
ø 83mm



Code	Description
DXGUF7CH	Tilt Chrome GU10 Fire Rated Die Cast Downlight Exc Lamp
DXGUF7PB	Tilt Polished Brass GU10 Fire Rated Die Cast Downlight Exc Lamp
DXGUF7SS	Tilt Satin Silver GU10 Fire Rated Die Cast Downlight Exc Lamp
DXGUF7W	Tilt White GU10 Fire Rated Die Cast Downlight Exc Lamp



-  IP65 Rated
-  Fire Rated
30/60/90 Minute Rated
-  Acoustic Rated
Part C Building Reg Compliant
-  Lifetime
Product Warranty

DAXGU10's

IP65 GU10 DIE CAST FIRE RATED DOWNLIGHT

- Fire rated IP65 downlight
- Die-cast aluminium twist & lock bezel
- 15 Amp large 3 terminal connector allows for loop-in/loop-out wiring
- Lifetime product warranty

Class
IP65 240V ⊕

Finish
Polished Brass,
Polished Chrome,
Satin Silver & White

Lamp
GU10 Cap
(Fitting Exc Lamp)

Construction
Body - Pressed Steel
Bezel - Die Cast Aluminium

Cutout Sizes
ø 73mm

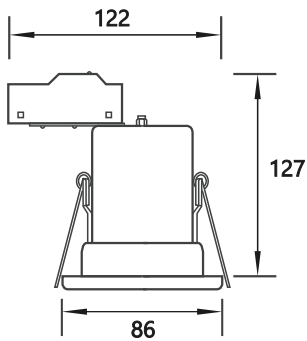

← DXGUF24W

DXGUF24CH →



← DXGUF24SS



DXGUF24PB →

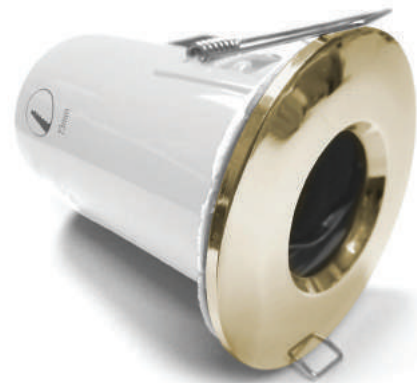

Code	Description
DXGUF24CH	IP65 Chrome GU10 Fire Rated Die Cast Downlight Exc Lamp
DXGUF24PB	IP65 Polished Brass GU10 Fire Rated Die Cast Downlight Exc Lamp
DXGUF24SS	IP65 Satin Silver GU10 Fire Rated Die Cast Downlight Exc Lamp
DXGUF24W	IP65 White GU10 Fire Rated Die Cast Downlight Exc Lamp



DAX-S/LITE's

8W LED BATHROOM SHAVER LIGHT

- Epistar brand 32 SMD LED tray
- Dual voltage
- Suitable for bathroom Zone 3 or outside zone
- Attractive slimline polycarbonate design

IP IP20 Rated

2 Year
Standard Product Warranty

SHAVER LIGHTS



↑ DXSLSMD8W



↑ DXSLSMD8C

Class
IP20 240V ⚡ ⚠

LED
Cool White 4000K CRI: Ra (90)

Wattage
8W

Lumens
480 Lumens | 68.5 Lm/W

Finish
White or Chrome

Construction
Body - Polycarbonate
Diffuser - Opal Polycarbonate

CE

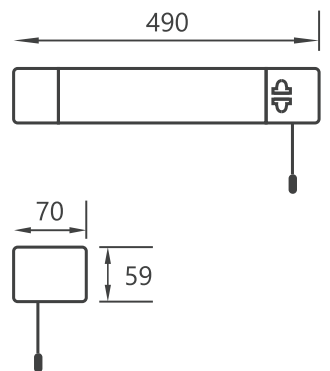

Code	Description
DXSLSMD8W	8W LED Shaver Light, White, Opal Diffuser
DXSLSMD8C	8W LED Shaver Light, Chrome, Opal Diffuser



IP IP20 Rated

2 Year
Standard Product Warranty

DAXDOWNLIGHT'S

18W RECESSED LED DOWNLIGHT

- High output LED downlight
- Direct replacement for PLC downlights
- Suitable for commercial and domestic environments
- 30,000 hours average lifetime

Class
IP20 240V ⚡

Wattage
18W

LED
6000K CRI: Ra (80)
4000K CRI: Ra (80)

Lumens
6000K 1325lm 74Lm/W
4000K 1250lm 69Lm/W

Finish
Matt White

Construction
Body - Die Cast Aluminium
Diffuser - Polycarbonate

Cutout Sizes
ø 200mm

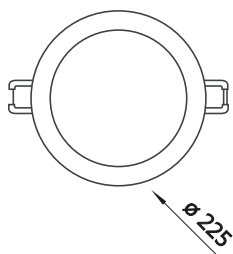
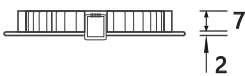

← DXLED18R6K



Code	Description
DX18R4K	18W Recessed LED Downlight. 4000K
DX18R6K	18W Recessed LED Downlight. 6000K



DAXBAT's

LOW PROFILE LED BATTENS

- High output LED batten
- Sleek aluminium/polycarbonate impact resistant profile
- Suitable for commercial and domestic environments
- Easy installation with integral solid quick release brackets



DXBAT120

Code	Description
DXBAT60CW	20W 2FT Low Profile LED Batten IP20 4000K
DXBAT60DL	20W 2FT Low Profile LED Batten IP20 6000K
DXBAT90CW	30W 3FT Low Profile LED Batten IP20 4000K
DXBAT90DL	30W 3FT Low Profile LED Batten IP20 6000K
DXBAT120CW	40W 4FT Low Profile LED Batten IP20 4000K
DXBAT120DL	40W 4FT Low Profile LED Batten IP20 6000K
DXBAT150CW	50W 5FT Low Profile LED Batten IP20 4000K
DXBAT150DL	50W 5FT Low Profile LED Batten IP20 6000K
DXBAT180CW	60W 6FT Low Profile LED Batten IP20 4000K
DXBAT180DL	60W 6FT Low Profile LED Batten IP20 6000K
DXBATKIT	LED Batten Suspension Kit

IP20 Rated

3 Year Standard Product Warranty

Class
IP20 240V

Wattage
20W/ 30W/ 40W/ 50W/ 60W

LED
6000K CRI: Ra(80)
4000K CRI: Ra(80)

Lumens
20W : 1900 Lm
30W : 2900 Lm
40W : 3800 Lm
50W : 4800 Lm
60W : 5700 Lm

Note:
Colour 4000K will be 100 Lm less.

Beam Angle
120°

Finish
White

Construction
Body - Aluminium/
Polycarbonate
Diffuser - Polycarbonate

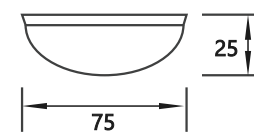

COMMERCIAL

IP IP20 Rated

5 Year
Standard Product Warranty

DAXPANEL'S

LED RECESSED CEILING PANELS

- High output LED ceiling panel
- Low profile white aluminium framed design
- Quick and easy installation

Class

IP20 240V ⊕

Wattage

42W / 45W / 75W Models

Lumens

DX60042W: 3300lm
 DX60045W4K: 3400lm
 DX60045W: 3600lm
 DX1206075W4K: 5800lm
 DX1206075W: 6000lm

Finish

White

Construction

Frame - Aluminium
 Diffuser - Opal Polycarbonate

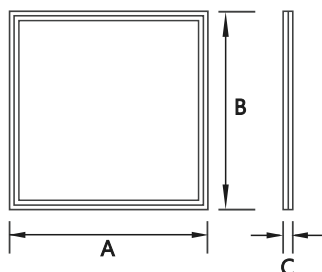

Dimensions: A x B x C

DX60042W: 595 x 595 x 10
 DX60045W4K: 595 x 595 x 10
 DX60045W: 595 x 595 x 10
 DX1206075W4K: 1195 x 595 x 10
 DX1206075W: 1195 x 595 x 10



↑ DX60045W



↑ DX1206075W

Code	Description
DX60042W	42W 595 x 595mm 6K c/w Philips driver ceiling panel
DX60045W4K	45W 595 x 595mm 4K ceiling panel
DX60045W	45W 595 x 595mm 6K ceiling panel
DX1206075W4K	75W 1195 x 595mm 4K ceiling panel
DX1206075W	75W 1195 x 595mm 6K ceiling panel
DXEM1PCK	Emergency pack 1 required for 60 x 60mm & 2 for 120 x 60mm
DX6SURKIT	600 x 600mm Surface mounting Frame
DX126SURKIT	1200 x 600mm Surface mounting Frame



DAXFLOOD'S

SLIMLINE LED EXTERIOR FLOODLIGHTS

- High output LED exterior lighting
- Slim profile galvanised die cast aluminium housing
- 30,000 hours average lifetime
- Suitable for domestic and commercial use



DXFLOOD30



IP IP65 Rated

2 Year
Standard Product Warranty

Class
IP65 240V ⚡

LED
6000K (CW) CRI: Ra (85)

Wattage
10W / 30W / 50W / 100W

Lumens
10W: 850 Lumens
30W: 2600 Lumens
50W: 4400 Lumens
100W: 9600 Lumens

Finish
Black

Construction
Body - Galvanised Die Cast Aluminium
Diffuser - Glass

CE

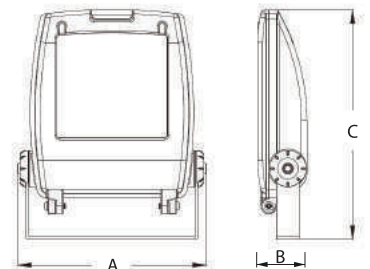

Dimensions: A x B x C
10W: 166 x 54 x 199
30W: 243 x 80 x 314
50W: 321 x 106 x 395
100W: 380 x 120 x 456

Code	Description
DXFLOOD10	10W LED Slimline Floodlight, Black Finish
DXFLOOD30	30W LED Slimline Floodlight, Black Finish
DXFLOOD50	50W LED Slimline Floodlight, Black Finish
DXFLOOD100	100W LED Slimline Floodlight, Black Finish

OUTDOOR

IP IP65 Rated

2 Year
Standard Product Warranty

DAXBRICK

EXTERIOR LED BRICKLIGHT

- Weather resistant exterior feature lighting
- Non-Tamper proof screws
- Stainless steel front face

Class

IP65 240V

LED

White 6000K CRI: Ra (85)

Wattage

2W

Lumens

125 Lumens

Finish

Stainless Steel

Construction

Body - Polycarbonate
Front Face - Stainless Steel
Diffuser - Polycarbonate

CE

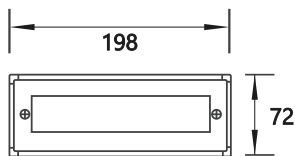

DXBRICKW

Code	Description
DXBRICKW	2W LED Exterior Bricklight



DAXDECKING

1W LED WALK-OVER DECKING LIGHTS

- Attractive low profile LED decking lights
- Weather resistant marine grade steel construction
- 30,000 hours average lifetime
- Various colour outputs



← DXGL016RD



DXGL016BL →



← DXGL016DL

Code	Description
DXGL016DL	1W LED Walk Over Decking Light Daylight
DXGL016BL	1W LED Walk Over Decking Light Blue
DXGL016RD	1W LED Walk Over Decking Light Red

IP IP68 Rated

1 Year Standard Product Warranty

Class
IP68 12V □ ▽
300ma – driver not supplied

LED
White 4000K CRI: Ra (85)
(Coloured Diffuser)

Wattage
1W

Lumens
116 Lumens

Finish
Anodised Aluminium

Construction
Body - Marine Grade Steel
Front Shield -
5mm Toughened Glass

Cutout Sizes
ø 50mm

CE

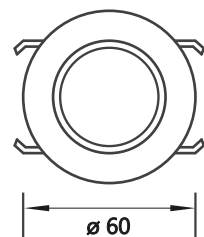
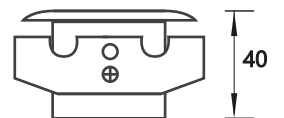

OUTDOOR



IP IP68 Rated

DAXGROUND

DRIVE OVER GROUND LIGHTS

- Drive over exterior feature lighting
- GU10/MR16 & MR11 Models
- Weather resistant anodised aluminium design

Class

IP68 240V/12V  

Lamp

DXGULVGRD50 -
GU10 or MR16 Cap Lamp

DXLVGRD35 -

MR11 Cap Lamp
(Fittings Exc Lamp)

Finish

Anodised Aluminium

Construction

Body - Anodised Aluminium
Sleeve - Plastic
Front Shield - Toughened Glass

Cutout Sizes

ø 68mm (DXGULVGRD50)
ø 52mm (DXLVGRD35)



DXLVGRD35

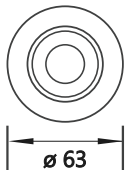
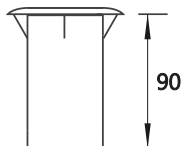

DXGULVGRD50

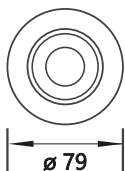
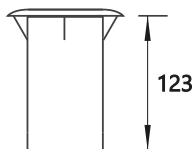

 DXGULVGRD50



DXLVGRD35 

Code	Description
DXGULVGRD50	GU10/MR16 Anodised Aluminium Drive Over Ground Light
DXLVGRD35	MR11 Anodised Aluminium Drive Over Ground Light



DXLMATE

LITEMATE LED RECHARGEABLE WORKLIGHT

- USB Rechargeable worklight. USB charging cable supplied
- Durable drop resistant design
- Fully charged in 2.5 hours. 4 hour use per charge
- On/Off power switch

IP IP20 Rated

2 Year
Standard Product Warranty

ACCESSORIES



← DXLMATE



Lumens
200

Class
IP20 240V

LED
6000K (CW)

Finish
White

Charging
Micro USB rechargeable

Construction
Body - Plastic

CE

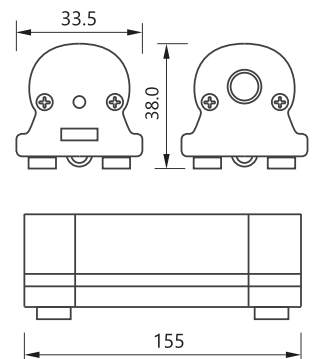

Code	Description
DXLMATE	Rechargeable LED Worklight. Magnetic Back.

 1 Year
Standard Product Warranty

DXGUH

GU10 LAMPHOLDERS

- For use with 240V GU10 cap lamps
- Ceramic holder with teflon sleeved cables



DXGUH 

Class
240V

Lamp
GU10 Cap

Construction
Body - Ceramic



Code	Description
DXGUH	240V GU10 Ceramic Lamp Holder

 1 Year
Standard Product Warranty

DX101C

20 AMP FAST FIX CONNECTOR

- 20 Amp 4 terminal connector
- Loop-in, loop-out connection facility
- Suitable for fixed wiring applications

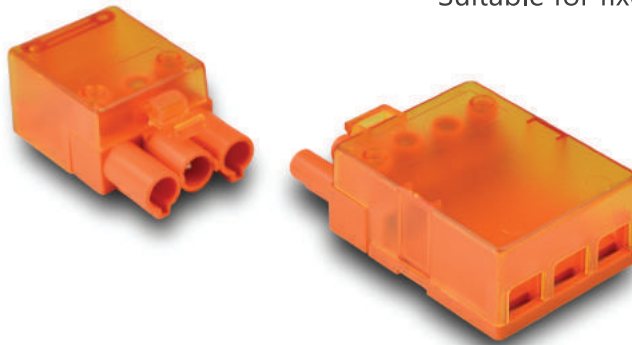

 DX101C

Class
240V

Finish
Orange

Construction
Body - Plastic



Code	Description
DX101C	20 Amp 4 Terminal Fast Fix Connector



DXLV13W

20W 12V CABINET LIGHT

- Surface mounted or recessed
- Suitable for kitchens



DXLV13W →

Code	Description
DXLV13W	20W 12V White Cabinet Light

IP IP20 Rated

1 Year
Standard Product Warranty

Class
IP20 12V

Lamp
20W G4 (Supplied)

Finish
White

Construction
Body - Steel

Cutout Sizes
ø 62mm

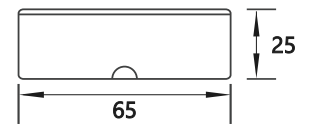

ACCESSORIES

OUR EXHIBITIONS

ALEXANDRA PALACE, LONDON - 31st Jan & 1st Feb 2018

EVENT CITY, MANCHESTER - 15th & 16th March 2018

WESTPOINT ARENA, EXETER - 19th & 20th April 2018

YEC, HARROGATE - 13th & 14th June 2018

RICOH ARENA, COVENTRY - 20th & 21st September 2018

SANDOWN PARK, SURREY - 1st & 2nd November 2018



SYMBOLS & MEANINGS

CATALOGUE ICONS

IP Ingress Protection

 Emergency Fitting/
Options Available

 Dimmable
Approved dimmers only

 Acoustic Rated
Part C Building Reg Compliant

LED LED Technology

 Product Warranty

 Fire Rated
30/60/90 Minute Rated

 PIR Sensor
Options Available

 Mountable on
flammable surfaces

HF High Frequency

 Double Insulated

CE European Conformity

 All products:
Not household refuse

 All products:
ROHS Compliant

 Standard Earth

Lumens (Lm) = A total amount of
the visible light emitted by the
source

COLOUR TEMPERATURE

Colour Temperature = Refers to characterisation of the spectral properties of a light source.

Low colour temperature is the warmer, more yellow to red light while the high colour temperature is the colder, more blue light Daylight.

The standard unit of measurement for the colour temperature is Kelvin (K). Some typical colour values include:

- 1000K = Equal to a candle flame
- 3000K = Equal to standard lamp (a warm orange colour)
- 4000K = Equal to warm yellow fluorescent
- 6000K = Equal to bright daylight blue

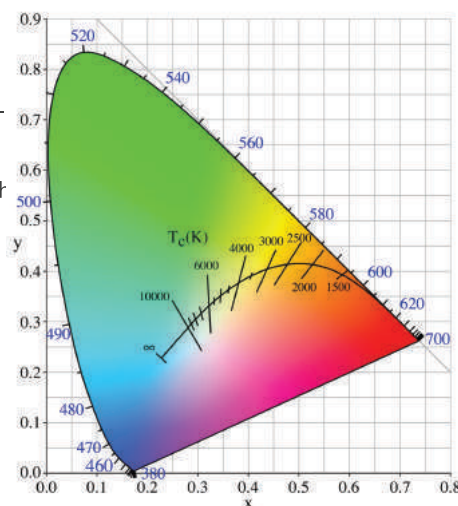

INGRESS PROTECTION

Ingress protection (IP) is a value given to products that have a particular protection against dust and/ or moisture. The IP number is split, the first digit represents the level of protection against dust particles while the second digit represents the protection against moisture.

FOREIGN BODIES

First Digit

- | | |
|----------|---|
| 0 | No protection |
| 1 | Protection against the ingress of objects larger than 50mm |
| 2 | Protection against the ingress of objects larger than 12.5mm |
| 3 | Protection against the ingress of objects larger than 2.5mm |
| 4 | Protection against the ingress of objects larger than 1mm |
| 5 | Protection against the ingress of dust in sufficient quantity to interfere with the satisfactory operation of the equipment |
| 6 | Complete protection against the ingress of dust |

FOREIGN BODIES

Second Digit

- | | |
|----------|---|
| 0 | No protection |
| 1 | Protection against drops of water falling vertically |
| 2 | Protection against drops of water falling at any angle up to 15° from the vertical |
| 3 | Protection against rain drops of water falling at any angle up to 60° from the vertical |
| 4 | Protection against liquid splashed from all practicable directions |
| 5 | Protection against low pressure jets of water from all practicable directions |
| 6 | Protection against heavy seas or strong jets of water from all practicable directions |

TERMS & CONDITIONS

1. GENERAL

In these conditions 'company' means DaxLite and 'the registered office' means the registered office for the time being of the company. The 'Buyer' means a company, firm or person who places an order with the company for the manufacture and/or supply of any goods.

2. THE COMPANY'S CONDITIONS

These terms and conditions shall apply to all contracts for the sale of goods entered into by the company to the exclusion of all other terms and conditions whether express or implied. No valuation of or additions to these terms and conditions shall be binding upon the company unless expressly accepted in writing under the hand of an authorised official of the company.

3. ACCEPTANCE

Unless previously withdrawn, quotations and tenders are open for acceptance for the period stated therein or if not period is stated, within thirty days from the date of thereof. Orders shall not be binding upon the company unless accepted by the company in writing and made subject to these conditions.

4. SPECIFICATION AND PERFORMANCE

The company reserves the right to change specification without prior notice as conditions warrant and any performance data, instructions or advices to the use of the goods given in the company's literature or included in the company's quotation or elsewhere shall not form part of this contract unless stated so to do in writing by the company.

5. PRICE

- (a) All prices include only such goods, accessories as in the quotation and are for the quantities expressed in conjunction with them. Any variation in quantity may entail the company varying the price of the goods.
- (b) All prices are subject to revision or withdrawal without notice.
- (c) All prices are subject to VAT at the appropriate rate, if applicable.
- (d) All prices in respect of orders for forward delivery are subject to the company's right to vary them.
- (e) At any time before delivery has been completed the company shall be entitled to vary the price of the goods to take into account all or any of the following factors:
 1. Where any of the goods are imported, any variation of official currency, exchange rates or special taxes or charges imposed by any government.
 2. Increased costs resulting from the prohibition or actions of any government.
 3. Increased material costs.
 4. All invoiced price discrepancies must be notified by the buyer to the company in writing within 7 days of the date of the invoice.

6. CARRIAGE AND METHOD OF FREIGHT

- (a) Deliveries in the United Kingdom Mainland will be subject to a minimum order charge of £200.00 ex VAT. Please contact the company for full details of carriage charges.
- (b) Orders for delivery outside the United Kingdom will be subject to an additional delivery charge unless otherwise agreed between the company and the buyer.

7. DELIVERY

- (a) The company shall not be liable for any loss or damage however caused by delay in delivering the goods or by non-delivery whether or not time of delivery is or shall have been made, of the essence of this agreement.
- (b) It is the buyer's duty to inform the company regarding delivery dates and arrangements in advance and to provide due warning and notice of any change in respect of such arrangements. If by reason of the buyer's default goods have not been taken up or delivered by the agreed delivery date, the company may (without prejudice to its rights to claim damages) suspend delivery of the goods or treat the contract as repudiated with regard to those goods, or store the goods at the expense of the buyer until they are taken up, or do any combination of the foregoing.

8. PROPERTY AND RISK IN THE GOODS

- (a) Subject to clause (b) hereof, property in the goods sold shall not pass to the buyer until full payment for the goods has been made to the company.
- (b) Between the date of delivery and the date of full payment by the buyer, the buyer shall be entitled to sell the goods whether or not incorporated in or with goods, and to deliver the same to a sub-buyer. Upon such delivery the property in the goods shall pass to the buyer unless by operation of the law it has previously passed to him. In selling the goods, whether or not the same have been incorporated in or with other goods, the buyer shall, as between himself and the company only, be deemed to be acting as agent for and as trustee of the company and shall hold such part of the proceeds of the sale made by him as its equivalent to the sum unpaid to the company as trustee of the company and shall keep such part of the proceeds as a separate and identifiable fund in the name of and as the property of the company.

9. PAYMENT

- (a) Payment shall be made before the expiration of the thirty days from date of invoice or in accordance with the other terms notified to the customer and shall be without deductions. In default of payment on the due date specified in the invoices, the company, without prejudice to its rights hereunder may charge the buyer interest on overdue accounts at the rate of 5% over bank rate for the time being or 20% whichever is the greater. The company shall at its discretion be entitled to withhold dispatch of goods until all monies owing to it by the buyer shall be paid in full. Without prejudice to any provision of these conditions the company may in its absolute discretion if doubts arise as to the buyer's solvency, suspend deliveries hereunder until satisfactory security has been given for due performance by the buyer of its obligations hereunder.
- (b) No special terms of payment will be operative unless confirmed in writing by a director of the company.
- (c) All payments must be made in sterling to the company at its registered office.

10. DESPATCH IN LOTS

The company shall have the right to despatch any portion of the goods covered by the contract and to invoice the buyer for such portion so despatched on the same terms and conditions set forth herein.

TERMS & CONDITIONS

11. LOSS OR DAMAGE IN TRANSIT AND NON-DELIVERY OF GOODS

No responsibility will be accepted by the company;

- (a) For any shortage or damage occurring in transit unless the buyer makes a claim in writing providing full particulars on both the carriers and the company at its registered office within 3 days of receipt of the goods.
- (b) For non-delivery of the goods unless the buyer makes a claim in writing providing full particulars on the carrier and company at its registered office within 7 days from the date of the company's advice note.

Where goods are collected by the buyer or the buyer's staff or agent, no claim for shortages or damage will be considered.

12. RETURN OF GOODS

In no circumstances may goods be supplied against a firm order be returned with the buyer having firm applied for and obtained the consent of the company. A handling charge may be deducted from any credit allowed by the company where the goods returned are not in the original packaging, of a resalable condition or where it is established that the reason for the return of the goods was not the subject of clause 11, hereof or due to any error on the part of the company.

13. CANCELLATION

Any order may be cancelled or varied by the buyer only with the consent of the company and on payment of reasonable cancellation or variation charges. Such charges shall take into account expenses incurred and commitments made by the company and all other losses due to such cancellation or variation. Cancellation cannot be accepted for purpose built goods i.e. specials.

14. FORCE MAJEURE

Should any event occur which is beyond the control of the company such as terrorism, strike, fire, flood, requisitioning of any other government action, accident or other act of God whereby the performance of this is prevented or delayed, the buyer may elect to cancel the contract in accordance with the cancellation provision contained in these conditions or allow the order to remain on the company's books and to be completed at some time later at an adjusted price. Where the buyer elects to allow the order to remain on the books, the buyer may at a later date elect to cancel the order subject to the said contract terms set forth herein.

15. GUARANTEE AND LIMITATION OF LIABILITY

- (a) The buyer shall have the benefit of and subject to such product guarantee as the company from time to time provides and the buyer is deemed to have full knowledge of the terms of such guarantees, copies of which will be supplied by the company on request and which are subject always to the buyer maintaining the goods supplied in accordance with the company's instructions.
- (b) Goods supplied by the company must be checked on delivery and before installation in case of damage in transit.
- (c) The company will make good, by repair or at the company's discretion by the supply of a replacement part, component or complete product items that have become defective, after proper storage and use, within a period of twelve months from the delivery date. The company's liability excludes other incidental costs such as labour and travelling expenses etc that might be incurred in replacing the defective item.
- (d) Save as provided by the above express guarantees, all representations, warranties, terms or conditions statutory or otherwise expressed or implied herein, or in any agreement collateral hereto in respect of the goods supplied or their use, are expressly excluded. Except to the extent contained in any such guarantee the company shall not be liable either in contract or in tort for any loss or damage, direct or indirect suffered by the buyer or by any persons in connection with the use of the goods, the function of which shall be the responsibility of the buyer and/or the installer.
- (e) In the event of the buyer not holding out as acquiring the goods in the course of business and not acquiring them in the course of business, clause 14 herein does not and will not affect his statutory rights.

16. CONSEQUENTIAL LOSS

The buyer, unless he does not acquire the goods in the course of business and does not hold himself out as acquiring them in the course of business, shall indemnify the company in respect of any loss, injury, damage, expense or claim of whatsoever nature and howsoever arising out of the contract or the goods or their storage, installation, use, operation, save where the same is caused solely by the negligence of the company.

17. SUBSTITUTIONS

If the company in its absolute discretion chooses to use alternative materials or parts, a substitute deemed by the company to be suitable for the intended purpose will be supplied if available, and shall be accepted by the buyer in full satisfaction and performance of the contract or that part thereof for which it is a substitute as the case may be, in the event that the company is unable to obtain a satisfactory substitute for unavailable materials or parts, the company's obligations to complete performance of the contract shall upon notification in writing to the buyer be suspended until such times as the unavailable materials or parts or a suitable substitute becomes available, and the price shall be adjusted accordingly.

18. BUYER'S CONDITIONS OF PURCHASE

Conditions set out in the buyer's enquiries or purchase orders are binding on the company only insofar as they do not conflict with the company's conditions of sale as set out herein.

19. OVERSEAS SALES

In the case of overseas sales the buyer shall be solely responsible for complying with any legislation or regulations governing the importation of the goods or the payment of any duties, levies or other sums of money on such importation..

20. GOVERNING LAW

This contract shall be governed and construed in accordance with the laws of England.



DaxLite

DaxLite Limited
17A Blackwater Trading Estate
Blackwater Way, Aldershot,
Hampshire,
GU12 4DN

www.daxlite.com

Sales:
Email: sales@daxlite.com
Tel: 01252 311016
Fax: 01252 330821

Technical:
Email: technical@daxlite.com

